

TCK-062

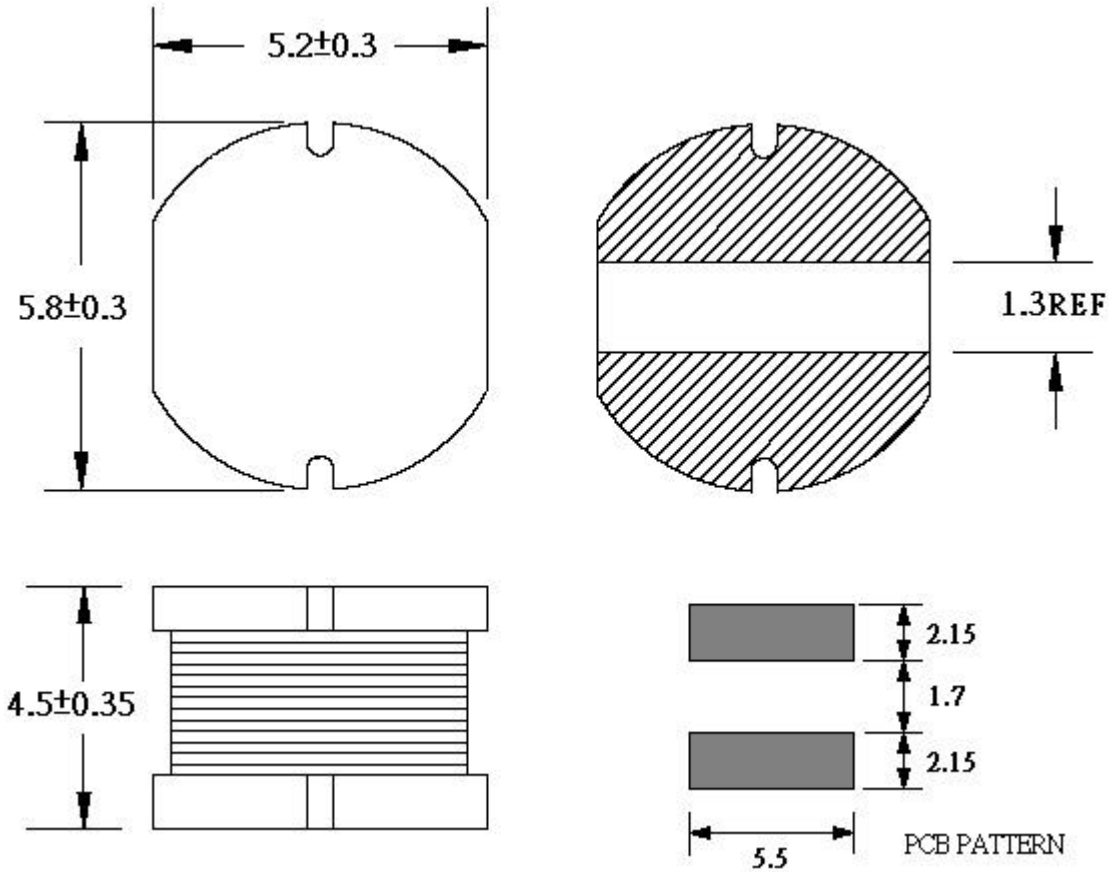

All dimensions in mm

SPECIFICATIONS		Common Mode Choke TCK-062
Inductance	$12\mu\text{H} \pm 20\%$	
	Test Condition: 1KHz/300mV Measurement Instrument: HP 4263B LCR Meter	
Impedance	DCR(Max): $120\text{m}\Omega$	
	Measurement Instrument: Agilent 34401A Meter	
Rated current	IDC(Max): 1.4A	
	Measurement Instrument: Agilent 34401A Meter	