

Screw_Terminal_01x04

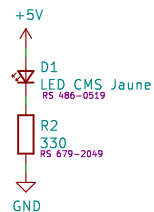

Appel urgence 2

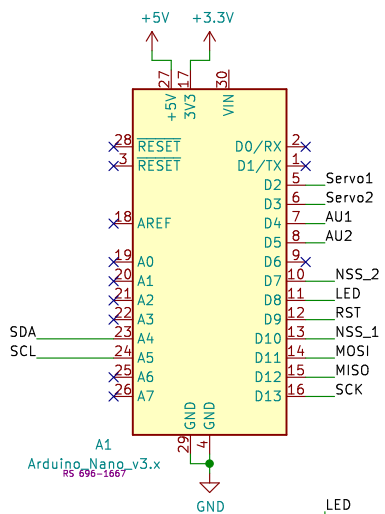

Arduino_Nano_v3.x

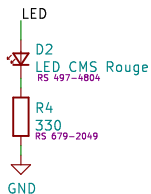

Appel urgence 1

Appel urgence 1

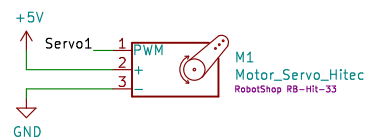
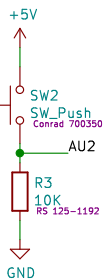
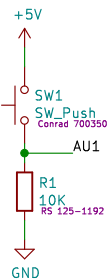

Barrière entrée

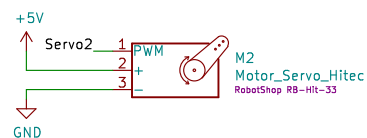

Barrière sortie

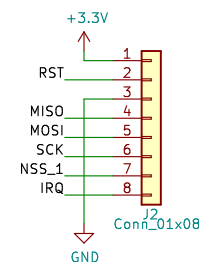

Lecteur entrée

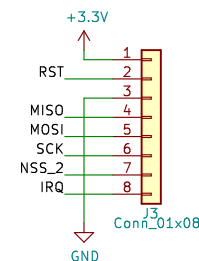

Lecteur sortie

Schéma structurel à tester / valider / modifier

Hortolland C.

Sheet: /

File: Parking_Nano.sch

Title: Smart City parking

Size: A4 Date: 2020-12-27

KiCad E.D.A. kicad (5.1.6)-1

Rev:

Id: 1/1