

Microstrip Calculation:

2-Layer
 Copper Thickness (1oz): 1.4mil/0.035mm
 Board thickness: 1.6mm/63mil
 Er: 4.6
 Polygon Isolation: 5mil
 RF Trace Width: 34mil
<https://saturnpcb.com/saturn-pcb-toolkit/>

u-blox MAX-M10S

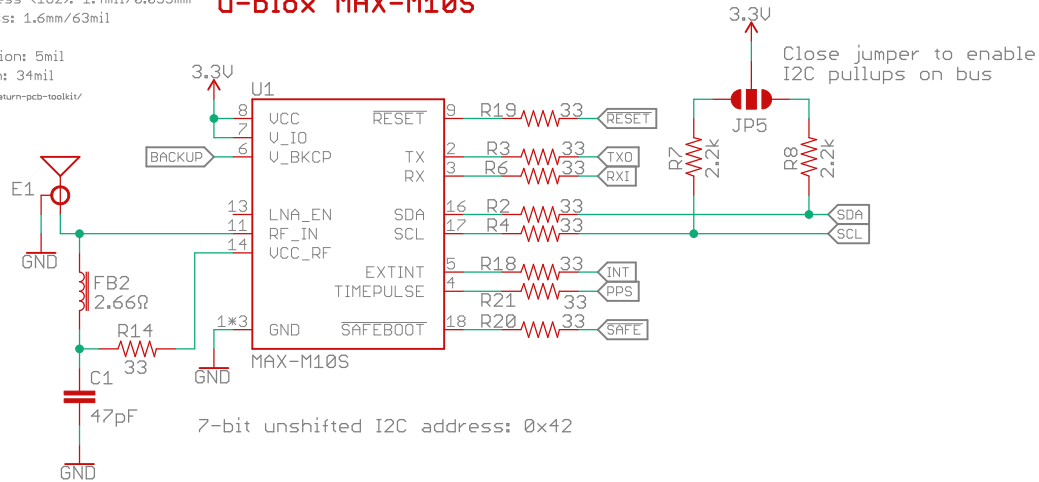

Stat LEDs

Cut jumper to disable LED

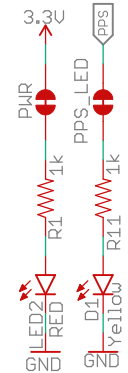

Connections

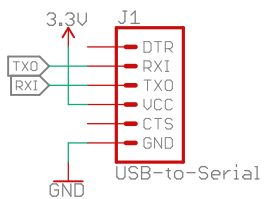
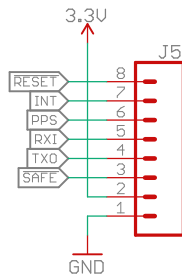
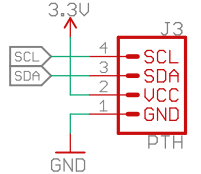
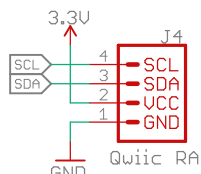
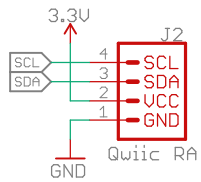

RTC Backup

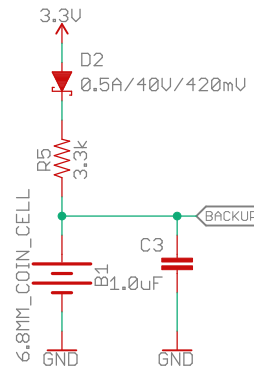

Released under the Creative Commons Attribution Share-Alike 4.0 License
<https://creativecommons.org/licenses/by-sa/4.0/>



TITLE: SparkFun u-blox GNSS MAX-M10S Special Instructions

Design by: REV: V10

Date: 3/5/2021 3:14 PM Sheet: 1/1